





## PRODUCT DESCRIPTION

AzoGrout 424™ is a flexible, hydrophobic polyurethane designed to stop water infiltration in concrete structures. Azo-Grout 424 used with Azo-Cat 24™ is a solvent-free, methyldiphenyl isocyanate (MDI)-based prepolymer, which will react with water. When cured in a free-rise situation, it will expand to about 750 percent of its original volume and yield to a 7-8 pound per cubic foot (pcf) foam.

Water Quality Association has tested AzoGrout 424 in accordance with the National Sanitation Federation (NSF) standard 61 and has approved this material for contact with potable water.

## PROPERTY OVERVIEW

|                         |   |
|-------------------------|---|
| <b>Viscosity</b>        |  |
| <b>Gel Time</b>         |  |
| <b>Tensile Strength</b> |  |
| <b>Elongation</b>       |  |
| <b>Flash Point</b>      | 390°F / 199°C   |
| <b>Color</b>            | Pale Yellow   |
| <b>Shelf Life</b>       | 1 Year  |
| <b>Sizes Available</b>  | <ul style="list-style-type: none"> <li>• 5 gallon</li> <li>• 55 gallon</li> </ul>   |

## PRODUCT APPLICATIONS



- Municipal and Utility Facilities**
  - Wastewater containment tanks
  - Cracks and joints
  
- Underground Parking Garages**
  - Sealing pipe openings
  - Expansion joints
  - Beam joints

- Concrete Crack Injections**
  - Honeycombed concrete areas
  - Flowing water leaks
  - Wet and dry cracks

- Concrete Dams and Powerhouse Galleys**
  - Flowing water leaks
  - Cracks and joints



\* For NSF/ANSI/CAN 61 and 372 use restrictions visit: [www.wqa.org](http://www.wqa.org)

**PROPERTIES OF AZO-GROUT 424**

**VISCOSITY AT 77°F/25°C**

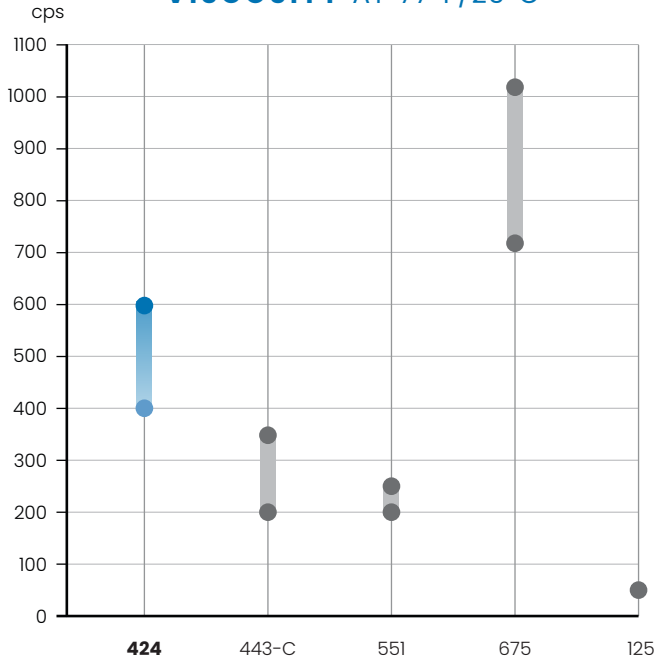

**GEL TIMES**

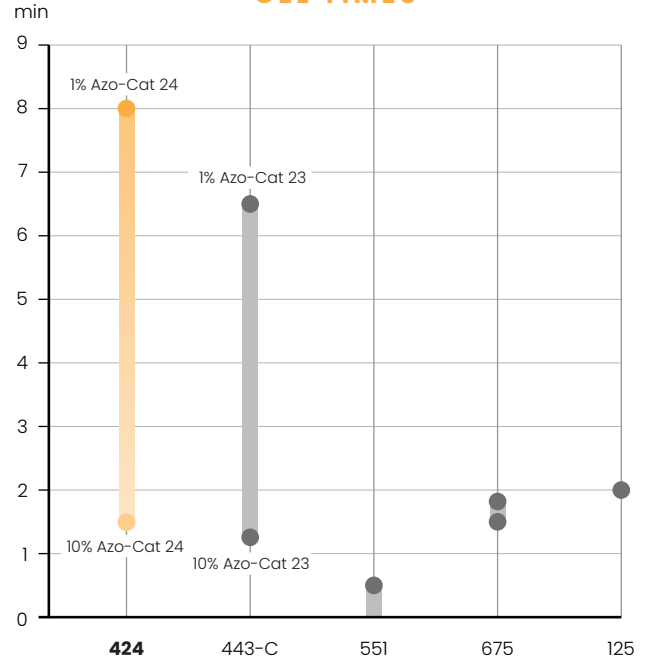

**TENSILE STRENGTH**

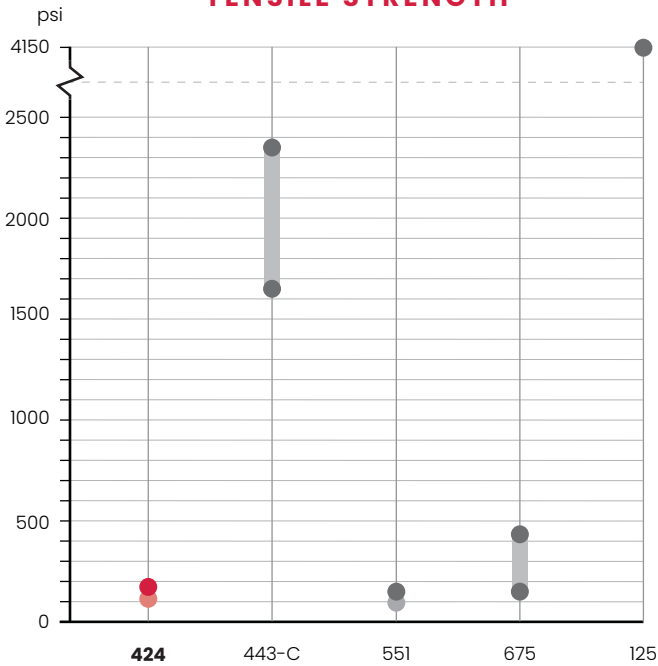

**ELONGATION**

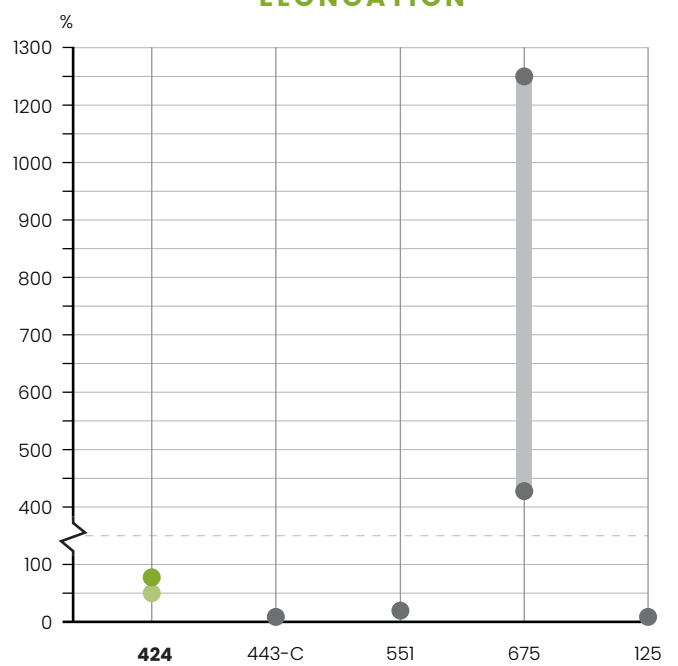

**TABLE 1: PHYSICAL PROPERTIES OF AZOGROUT 424 (UNCURED)**

| Property                   | Value           | Test Method |
|----------------------------|-----------------|-------------|
| Color                      | Pale Yellow     | Visual      |
| Specific Gravity           | 1.04 - 1.07     | ASTM D891   |
| Viscosity at 77 °F (25 °C) | 400-600 cps     | ASTM D2196  |
| Storage Stability          | 1 Year          |             |
| Solids                     | 100 %           |             |
| Corrosiveness              | Non-Corrosive   |             |
| Flash Point                | 390 °F (199 °C) |             |

**TABLE 2: PHYSICAL PROPERTIES OF AZOGROUT 424 (CURED)**

| Property            | Value       | Test Method |
|---------------------|-------------|-------------|
| Tensile Strength    | 140-180 psi | ASTM D638   |
| Elongation          | 45 - 85 %   | ASTM D638   |
| Shrinkage by Weight | 0 %         | In-House    |
| Shrinkage by Volume | 3 %         | In-House    |
| Toxicity            | Non-Toxic   |             |

## HOW TO USE

### HAND-MIX REACTIVITY CHECK

A pre-blend reactivity test can be performed by hand-mixing in cups. Azo-Cat 24 can be added to Azo-Grout 424 prior to mixing with water to accelerate the reaction time. The recommended procedure for a reactivity check is:

**Recipe:**

- 100 Parts by Weight of AzoGrout 424
- 10 Parts by Weight of Azo-Cat 24
- 5 Parts by Weight of Water

**Steps:**

1. Add the Azo-Cat 24 to the AzoGrout 424 and homogenize
2. Add the water and mix thoroughly
3. Using the start time as the time mixing begins after the addition of the water:
  - a. Determine the cream time (the time in which the material just begins to foam)
  - b. Determine the tack-free time (the time in which the surface of the material is no longer tacky)

### SITE PREPERATION

**Steps:**

1. Using a hammer drill with a masonry bit, prepare the work site by drilling holes at approximately a 45° angle to intersect the application site at about half the depth of the fissure. Holes are typically drilled on opposing sides of the application site in an alternating pattern. The spacing is dependent on the crack size.
2. Flush drill waste from the hole prior to installing packers. Adding water to the injection site aids the foaming reaction of AzoGrout™ within the crack.
3. Securely install injection packers in the pre-drilled holes. Press the packer into the first hole, then tap it firmly with a hammer to ensure the tip is fully inserted. Continue installing injection packers until all of the holes are filled.

\*Azon injection packers are available to order in a variety of sizes.

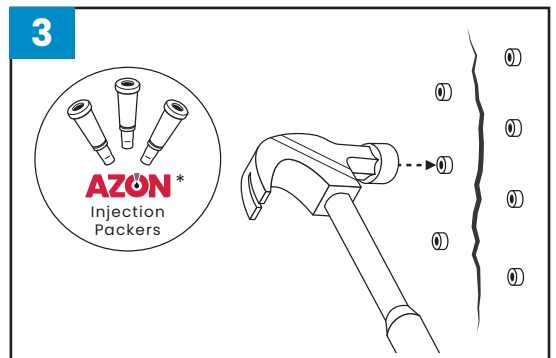
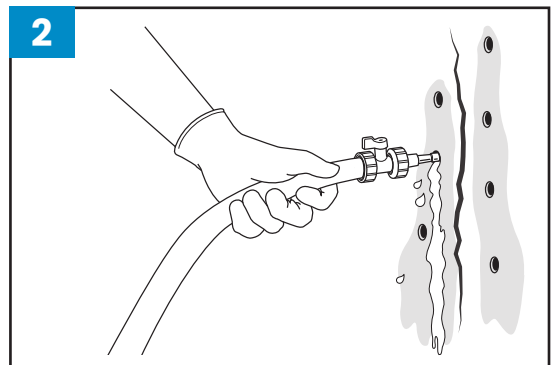
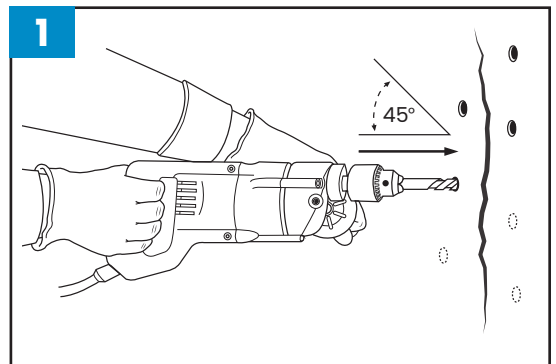

**TABLE 3: EFFECT OF AZO-CAT 24 ON GEL TIME AT 77 °F (25 °C)**

| Azo-Cat 24 Level | Start of Rise    | Top of Rise    | Product        |
|------------------|------------------|----------------|----------------|
| 1 %              | 1.83 min (110 s) | 8 min (480 s)  | Resilient Foam |
| 3 %              | 0.67 min (40 s)  | 5 min (300 s)  | Resilient Foam |
| 10 %             | .25 min (15 s)   | 1.5 min (90 s) | Resilient Foam |

Table 3 indicates how varying amounts of Azo-Cat 24 affect gel time. Note that the temperature of the components will also affect the reaction time; hotter materials will decrease the reaction or working time and colder materials will increase the reaction time. Furthermore, pH and other factors present within the application site may affect the reaction or work time.

**APPLICATION METHOD**

After performing the hand-mix reactivity check, mix the proper amount of Azo-Cat 24 to AzoGrout 424 to obtain the desired gel time shown in Table 3. As noted, temperatures of the repair area at the job site may also affect actual reaction speed. Start with a quantity of material that can be applied in a reasonable amount of time. Inject the mixture using a single-component injection pump. If the crack is dry, inject water through each packer first using a separate pump. The use of a second pump for injecting water reduces the risk of having a reaction, resulting in a clogged pump.

Flush the pump and all mechanical components of all residual grout when injection is finished with Azo-Purge MP2™.



Note: Depending on the scope of the project, it may be advisable to consult a manufacturer’s representative during installation.

**PRECAUTIONS**

This material is intended to be used by trained professionals with the proper equipment. The following safety measures are recommended:

- Wear protective gloves, clothing, goggles, hearing protection for noise reduction, and hard hats for falling debris.
- Do not eat, drink, or smoke while in active contact with these materials.
- Avoid skin contact.
- Wash hands thoroughly with soap and cool water. Never wash the skin with a solvent.
- Anyone experiencing difficulty breathing when working with these materials or showing an allergic reaction should seek fresh air immediately and consult a physician if symptoms persist.

## MATERIAL STORAGE

Open containers of material should be used quickly to avoid moisture contamination. If a container needs to be resealed, it should be blanketed with nitrogen or dry air [less than -40° F (-40° C) dew point] to minimize water exposure. Refer to the safety data sheets (SDS) for further information regarding these materials. All spills of AzoGrout 424 should be cleaned up by absorbing the grout into an inert material and then transferring the mixture to an open top drum. Do not seal the waste drums for 24 hours to allow the AzoGrout 424 to react completely. Dispose of waste material in accordance with state and local regulations.

## PACKAGING

AzoGrout 424 is available in 5-gallon pails (45 pounds) and 55-gallon drums at (463 pounds).

**WARRANTY:** The information contained in this document is to assist customers in determining whether our products are suitable for their applications. Our products are intended for sale to industrial and commercial customers. The customer must inspect and test our products before use, and satisfy themselves as to the contents and suitability. Nothing herein shall constitute a warranty, expressed or implied, including any warranty of merchantability or fitness, nor is protection from any law or patent to be inferred. All patent rights are reserved. The exclusive remedy for all proven claims is replacement of our materials, and in no event shall we be liable for special, incidental, or consequential damages.

**Azon USA, Inc.**  
2204 Ravine Rd.  
Kalamazoo, MI 49004  
269.385.5942  
[azogrout.com](http://azogrout.com)