





PRODUCT DESCRIPTION

AzoGrout 680LV is a single component, hydrophilic, polyurethane grout that cures when mixed with water. It becomes a resilient, flexible, rubber-foam when it comes into contact with water. Its high absorption capability makes it ideal for use in areas where water is always present or where there is heavy water inflow. Its low viscosity is appropriate for penetrating fine cracks. AzoGrout 680LV can absorb up to 50% of its volume in water.

PROPERTY OVERVIEW

Viscosity	
Gel Time	
Tensile Strength	
Elongation	
Flash Point	> 212°F / 100°C
Color	Light Yellow
Shelf Life	1 Year
Sizes Available	<ul style="list-style-type: none"> • 5 gallon • 55 gallon

PRODUCT APPLICATIONS



• Pedestrian and Automotive Tunnels

- Curtain injection
- Gel encapsulation
- Joint and crack sealing

• Municipal and Utility Facilities

- Precast manhole joints
- Brick manholes
- Sewer pipes

• Concrete Dams and Powerhouse Galleys

- Curtain injection
- Gel encapsulation



TABLE 1: PHYSICAL PROPERTIES OF AZOGROUT 680LV (UNCURED)

Property	Value	Test Method
Color	Light Yellow	Visual
Specific Gravity	1.08 - 1.086	ASTM D891
Viscosity at 77 °F (25 °C)	725 - 1025 cps	ASTM D2196
Storage Stability	1 Year	
Flash Point	>212 °F (>100 °C)	

TABLE 2: PHYSICAL PROPERTIES OF MATERIALS (CURED)

Property	1 Water : 2 Grout Ratio	Measurement	Test Method
Gel Time	Clear	80 ± 5	
Tensile Strength	45 ± 11	psi	ASTM D412
Elongation	230 ± 85	percent	ASTM D412
Die-C Tear	11 ± 1	pii	
Physical Form	Resilient Foam		

HOW TO USE

PREPERATION

AzoGrout 680LV can be injected as a single component when sufficient water is present. In certain situations, it is recommended to inject water as a second component by using a mixing and metering machine.

APPLICATION METHODS

Crack Injection

1. Using a hammer drill with a masonry bit, prepare the work site by drilling holes at approximately a 45° angle to intersect the application site at about half the depth of the fissure. Holes are typically drilled on opposing sides of the application site in an alternating pattern. The spacing is dependent on the crack size.

2. Flush drill waste from the hole prior to installing packers.

3. Securely install injection packers in the pre-drilled holes. Press the packer into the first hole, then tap it firmly with a hammer to ensure the tip is fully inserted. Continue installing injection packers until all of the holes are filled.

*Azon injection packers are available to order in a variety of sizes.

4. Begin injecting grout into the packers.

For construction joints in manholes:

Mix 2 parts AzoGrout 680LV to 1 part water.

The mixture can be injected directly into the joint.

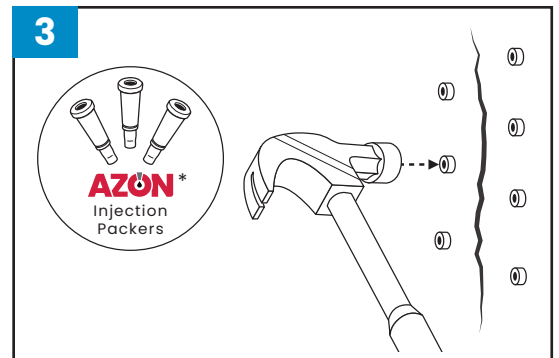
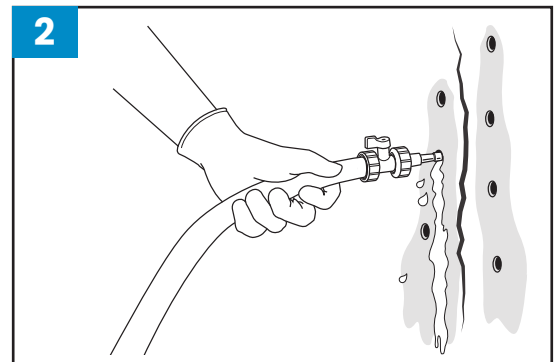
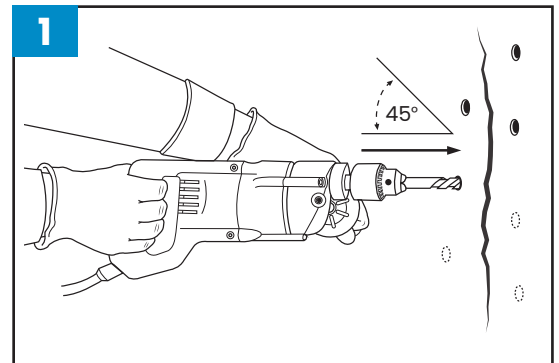

Curtain Injection

A grout curtain can be used to encapsulate and seal a leak in below grade structures. From inside the structure, drill holes completely through to the outside to allow the injection to take place from the inside. The pattern and spacing of the holes depend on the size of the repair. A diamond pattern is often used. Install packers into the holes and begin injecting the grout into the injection packers, beginning with the packer in the lowest corner. Continue injecting until the grout into the packers, working your way up. Inject as much material as the packer will accept. You may need to repeat injections on previous packers. The goal is to fill the void to create a waterproof seal on the outside of the structure.

Activated Oakum Technique

A method to help reduce or eliminate heavy water inflow in wide cracks or joints is called the activated oakum technique. First start by saturating oakum rope or industrial absorbent towels in the grout and then soaking the rope or towels in water. The grout will begin reacting once dipped in the water. Place the saturated pieces into the leaking crack or joint. Push deeply into the crevice using a blunt instrument. Once the water infiltration has been substantially reduced, drill holes and proceed with either the encapsulation or the crack injection method as described above.

Clean-Up

After the injection is completed, flush the pump and all mechanical components with Azo-Purge MP2 to remove any residual grout.

WARRANTY: The information contained in this document is to assist customers in determining whether our products are suitable for their applications. Our products are intended for sale to industrial and commercial customers. The customer must inspect and test our products before use, and satisfy themselves as to the contents and suitability. Nothing herein shall constitute a warranty, expressed or implied, including any warranty of merchantability or fitness, nor is protection from any law or patent to be inferred. All patent rights are reserved. The exclusive remedy for all proven claims is replacement of our materials, and in no event shall we be liable for special, incidental, or consequential damages.

PRECAUTIONS

This material is intended to be used by trained professionals with the proper equipment. The following safety measures are recommended:

- Wear protective gloves, clothing, goggles, hearing protection for noise reduction, and hard hats for falling debris.
- Do not eat, drink, or smoke while in active contact with these materials.
- Avoid skin contact.
- Wash hands thoroughly with soap and cool water. Never wash the skin with a solvent.
- Anyone experiencing difficulty breathing when working with these materials or showing an allergic reaction should seek fresh air immediately and consult a physician if symptoms persist.

MATERIAL STORAGE

Store in dry conditions in unopened, tightly closed, original containers and within a temperature range of 40° F and 85° F (5° C and 30° C). AzoGrout 675 has a shelf life of 12 months. Dispose of waste material in accordance with state and local regulations.

PACKAGING

AzoGrout 680LV is available in 5-gallon pails (45 pounds) and 55-gallon drums at (463 pounds).